

製品図

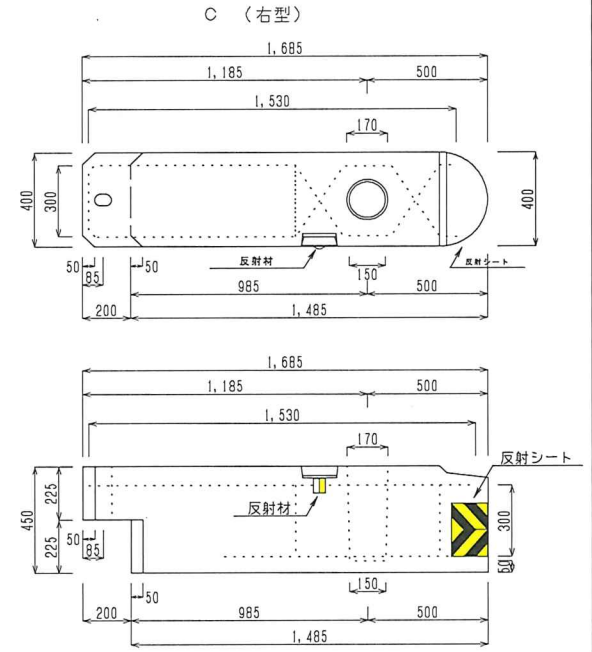

A-1 (基本型1m)

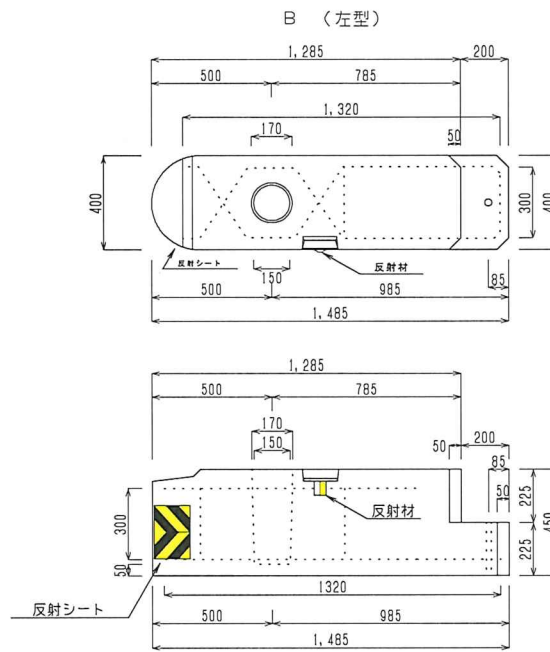
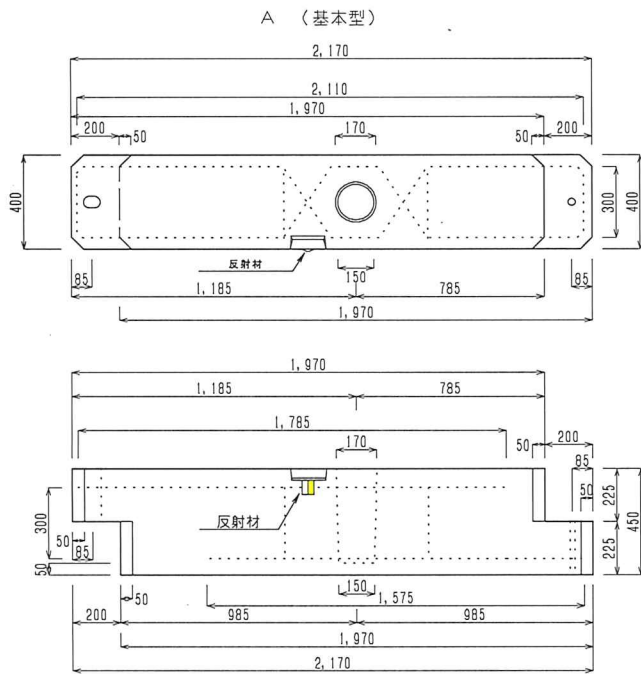
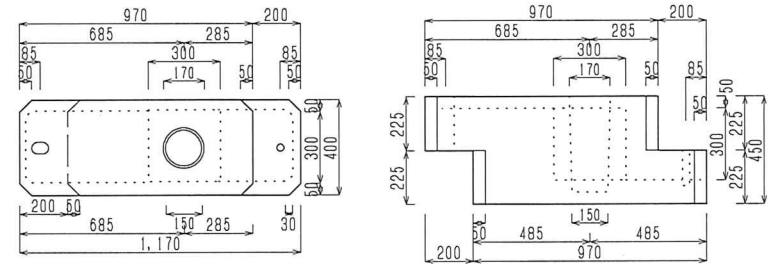

施工図

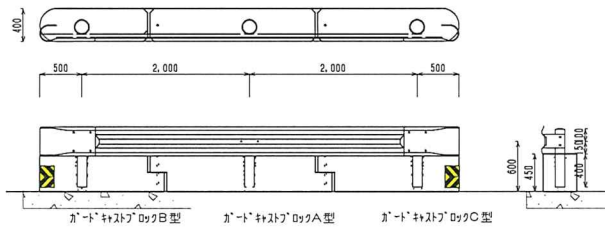

部品図

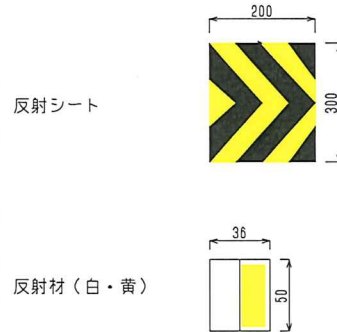

ガードキャストブロック I型 (据置きタイプ)

1970×400×450 I型

SCALE: 1/22

三和産業株式会社



製品図

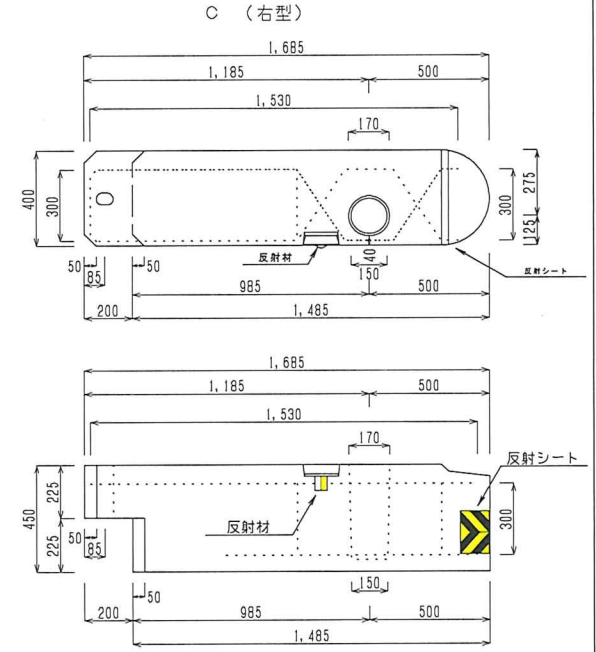
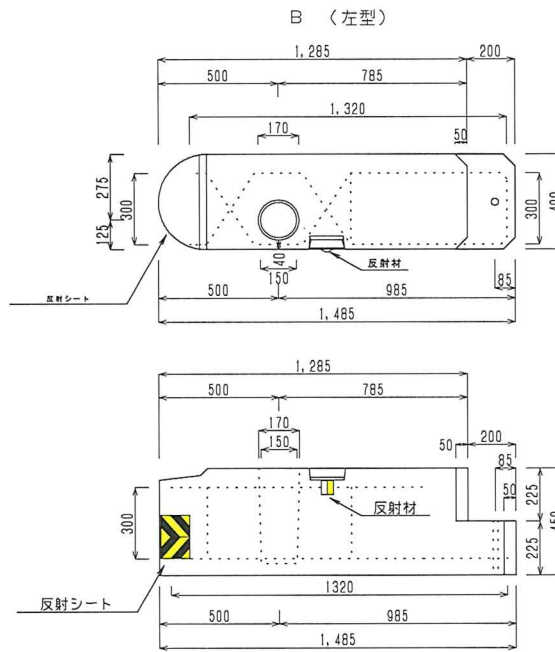
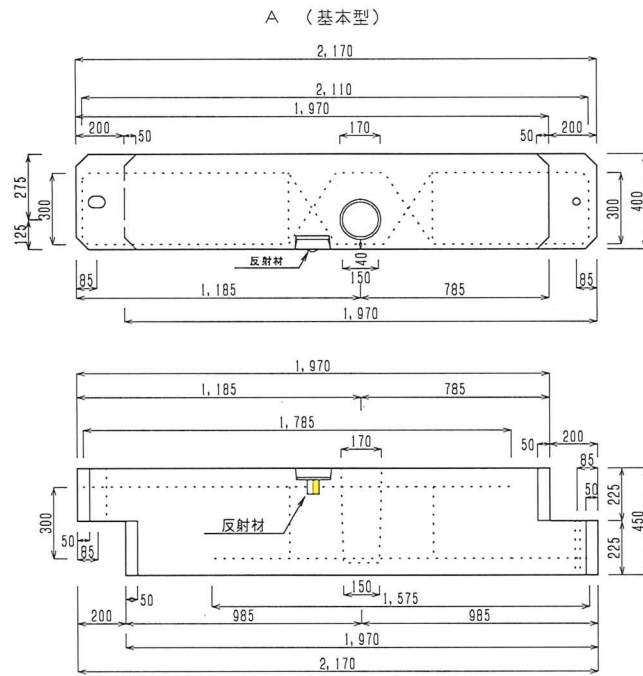

A-1 (基本型1m)

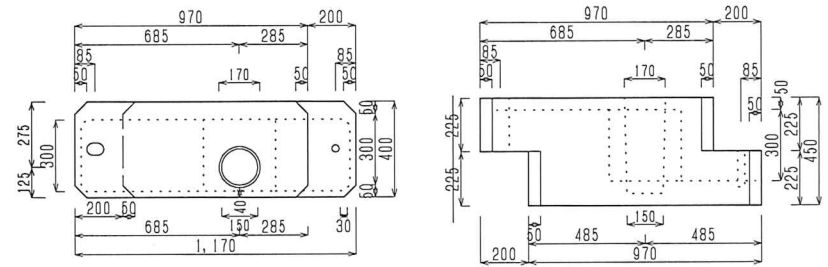

施工図

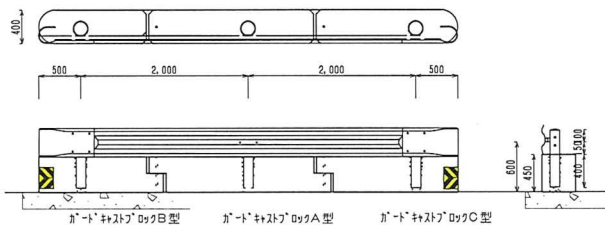

部品図

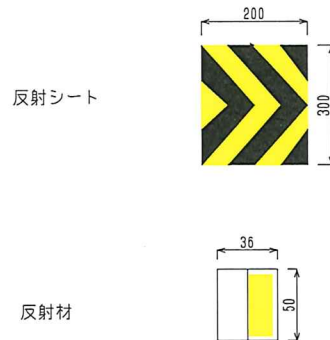

ガードキャストブロック I 型 (据置きタイプ)

1970×400×450 I 型

S=1/22

三和産業株式会社



製品図

A (基本型)

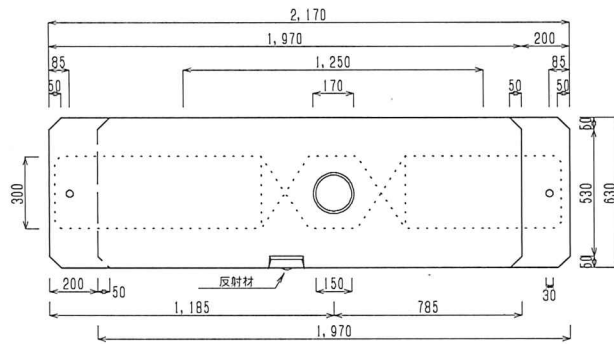

B (左型)

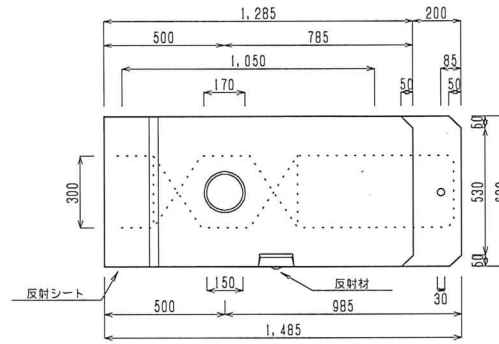

C (右型)

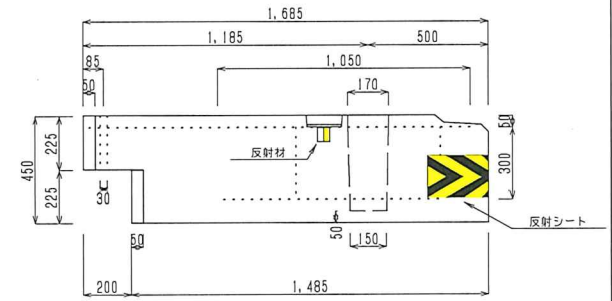
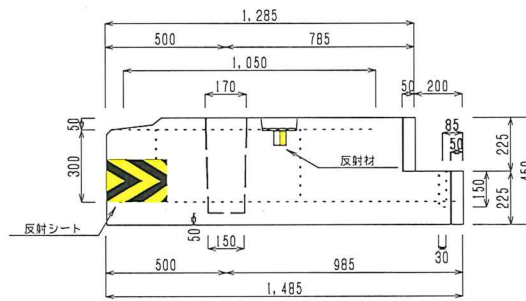
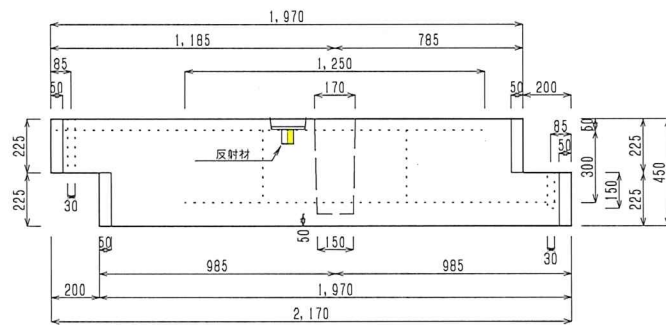
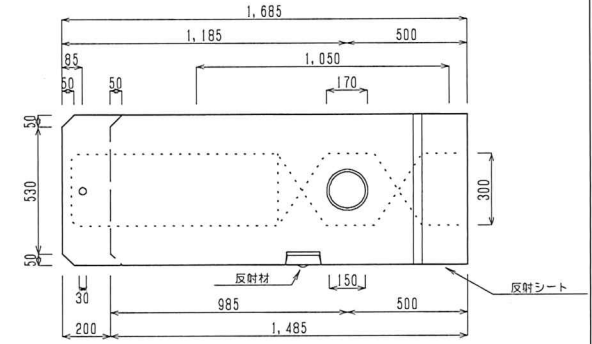

A-1 (基本型) m

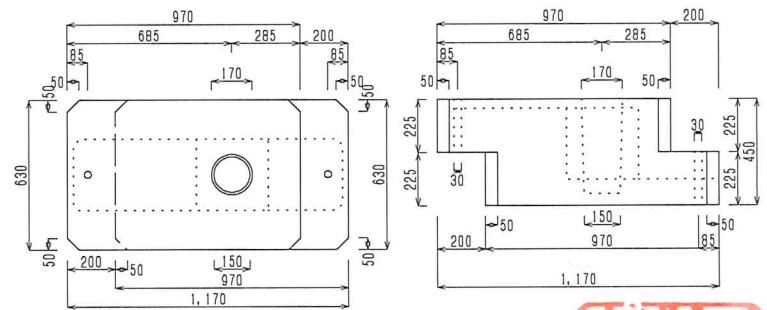

施工図

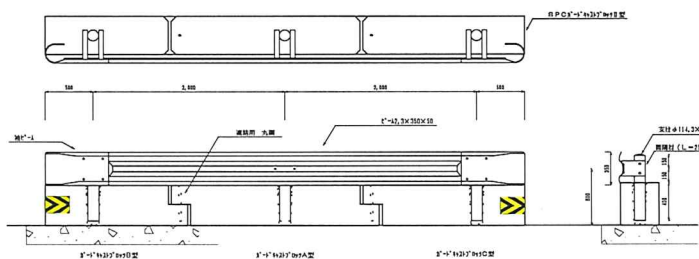

反射シート



反射材

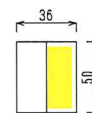

SPCガードキャストブロック II型(据置型)

1970×630×450

SCALE: 1/22

三和産業株式会社



製品図

A (基本型)

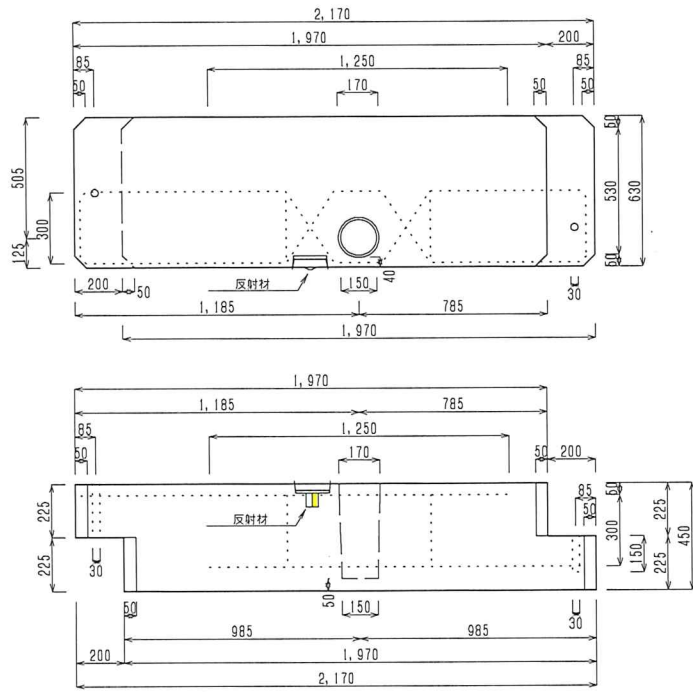

B (左型)

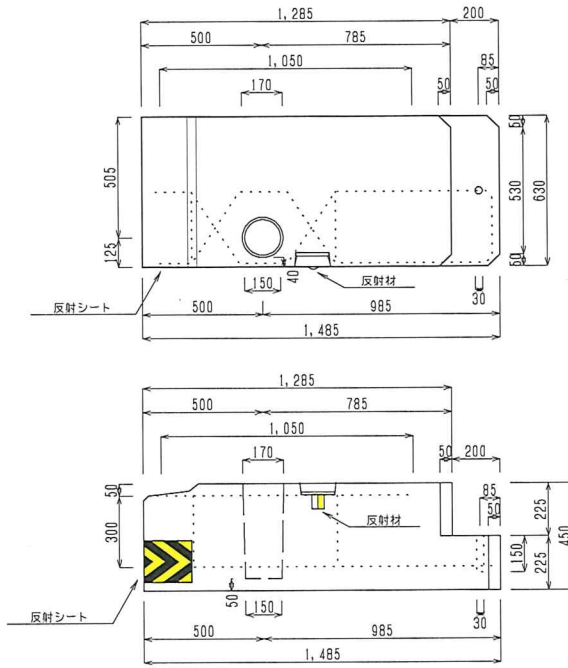

C (右型)

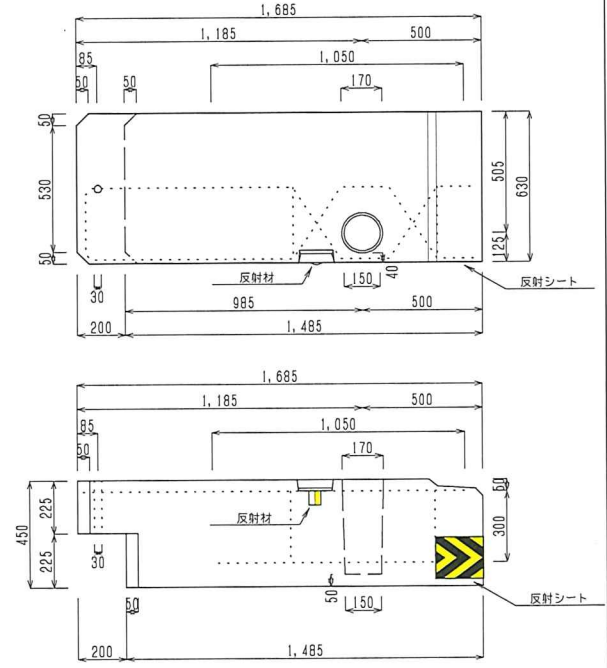

A-1 (基本型1m)

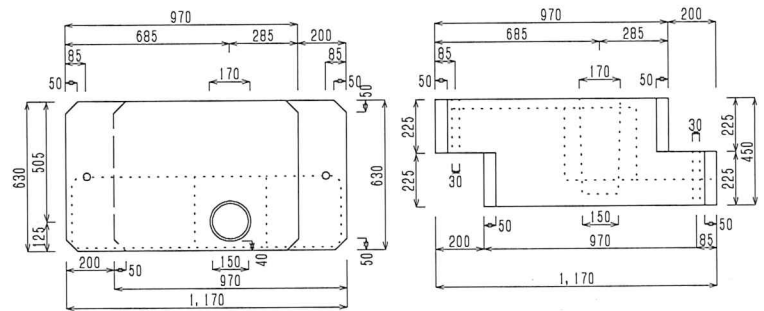

施工図

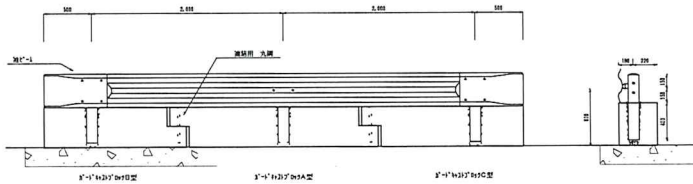

反射シート



反射材

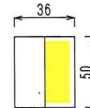

SPCガードキャストブロック II型

1970×630×450

SCALE: 1/22

三和産業株式会社

